

High Density, Low Profile Mezzanine Connectors

- 50, 100, and 140 contact versions
- 0.050 [1.27] pitch high density connector
- 0.343 [8.71] stacking height
- Low profile and light weight
- Optional snap-on mounting brackets
- 0.40mm diameter hyperboloid sockets
- Long life, high reliability contact system
- Inherent keying offsets
- Glass filled LCP insulators
- Gold and solder tail options available
- For through-hole printed circuit board up to 0.125 [3.18]

General Specifications	
Number Contacts	50, 100, 140
Pitch	0.050 [1.27]
Current Rating	1 Amp per contact
Contact Resistance	< 8 milliohms
Extraction Force	0.3 to 1.6 oz.
Contact Life Cycles	Up to 100,000
Insulation Resistance	10 megohms at 500 VDC
Dielectric Withstanding Voltage	500V RMS
Temperature Rating	-55° to 125° C
Insulator Material	LCP (liquid crystal polymer)
Contact Plating	
Pin	50µin gold over nickel
Socket	50µin gold over nickel
Printed Circuit Board Plated Through-Hole Diameter	0.021 [0.53]
Termination Length	0.157 [4.00]
Flammability Rating	UL94-V0

Optional Mounting Brackets

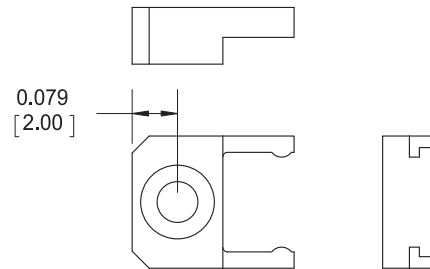

Stacking Height Between Boards Without Mounting Brackets

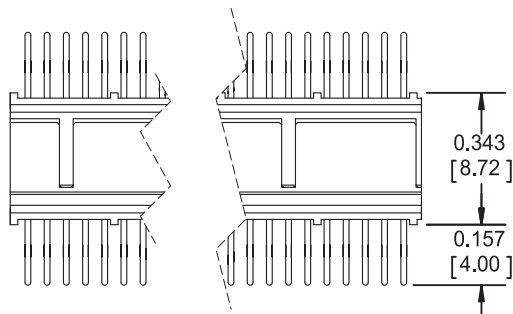

Stacking Height Between Boards With Mounting Brackets

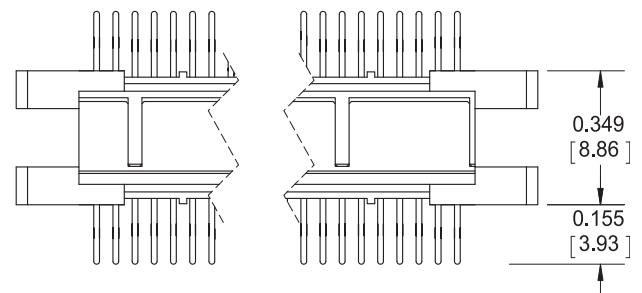

Dimensions are in inches [mm]

Receptacle

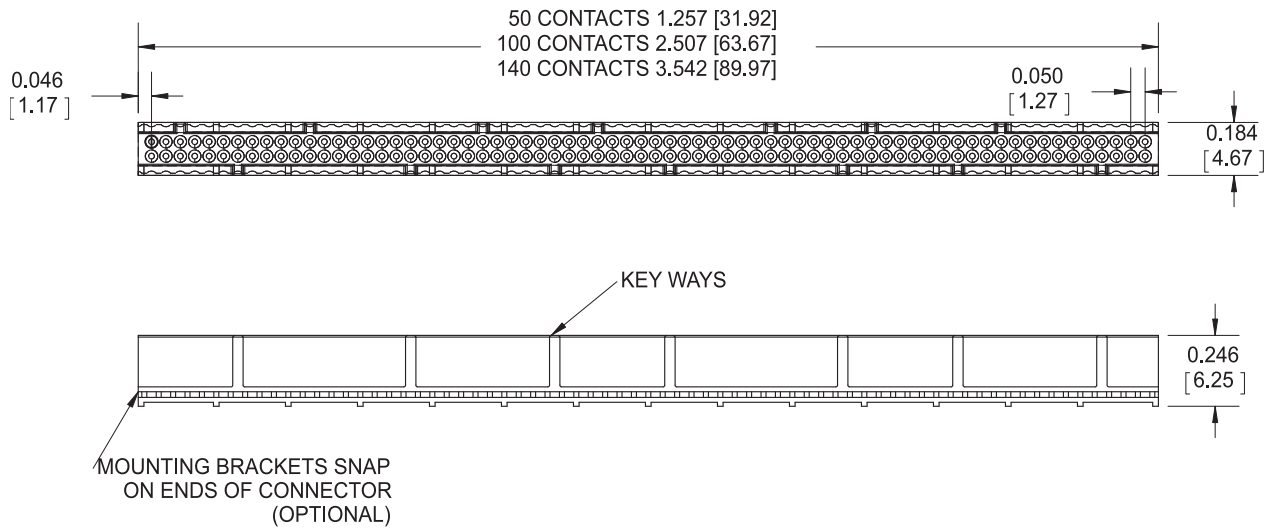

Plug

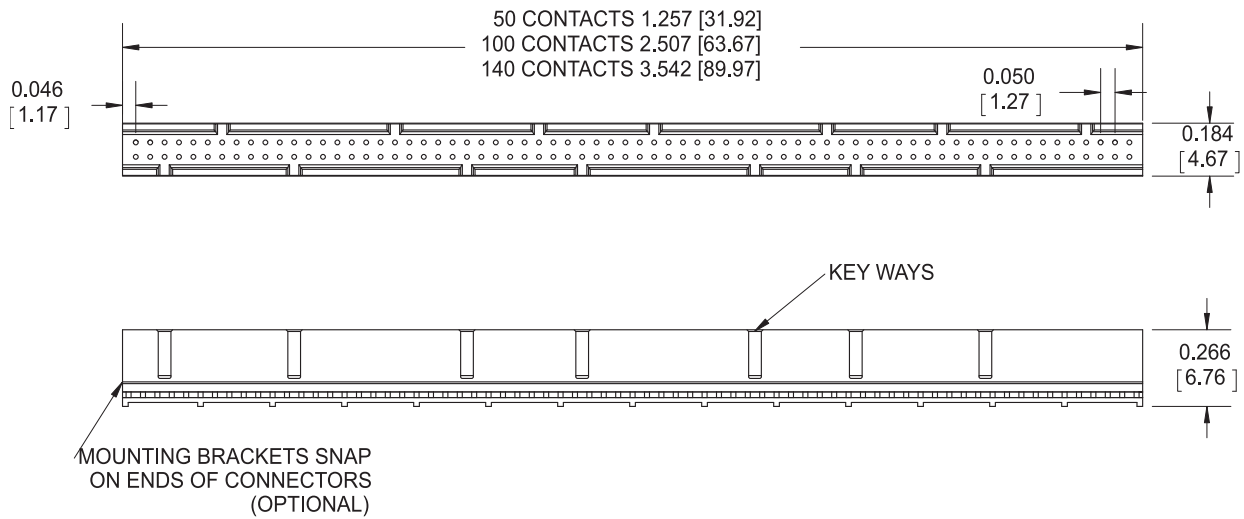

Receptacle Termination

Plug Termination

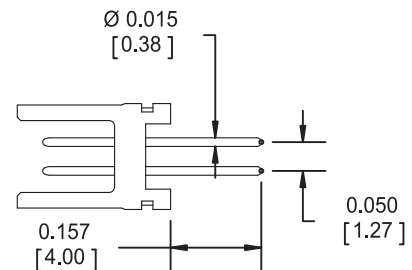
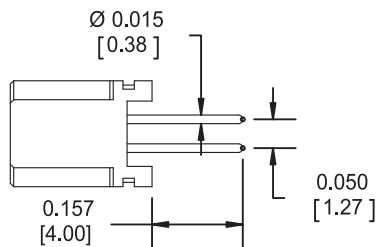

Dimensions are in inches [mm]

Straight Solder Printed Circuit Board Hole Layout

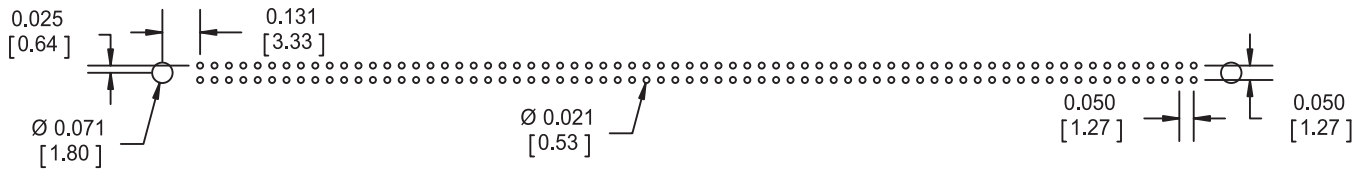

Ordering Information

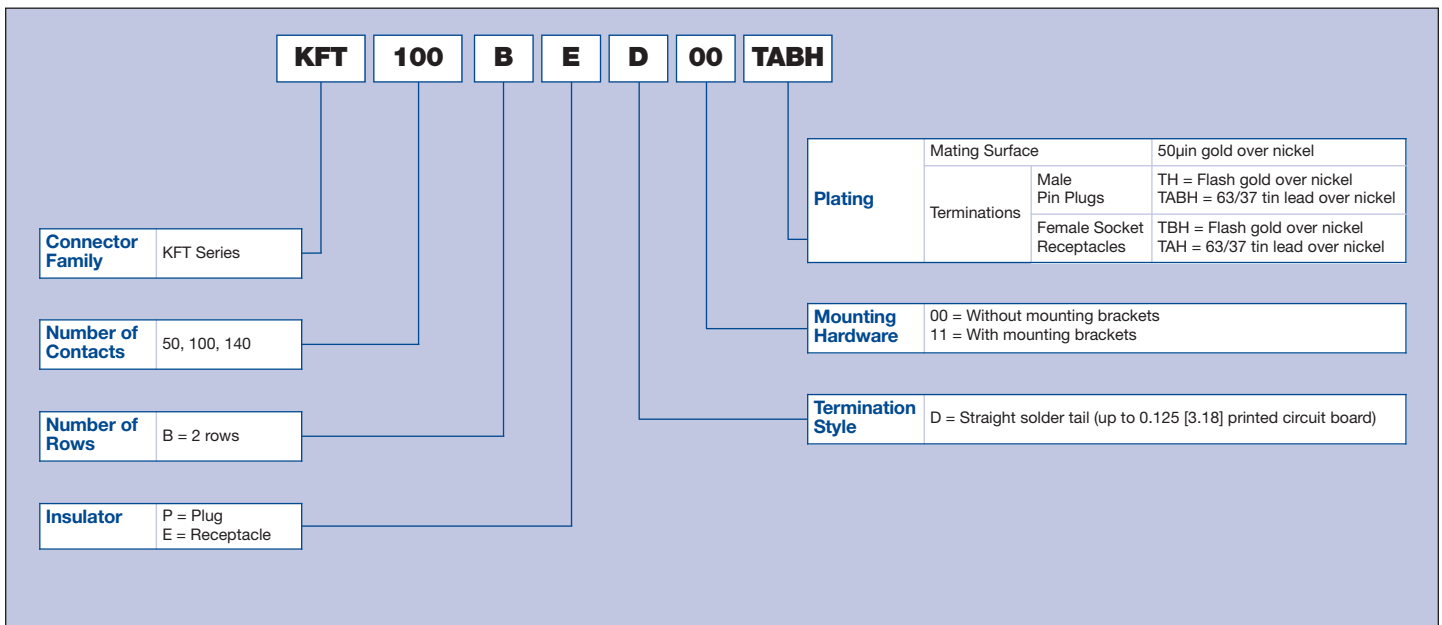

Dimensions are in inches [mm]